

PHF TB3535X75MM

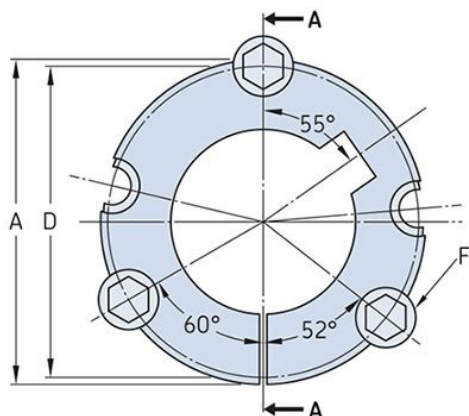

Bushing no.	TB3535
d = Bore diameter (mm)	75
Bore diameter (in)	2.95
Keyway width (mm)	20
Keyway width (in)	0.79
Keyway depth (mm)	4.9
Keyway depth (in)	0.19
A (mm)	127
A (in)	5
B (mm)	89
B (in)	3.5
D (mm)	123
D (in)	4.84
E (mm)	-
E (in)	-
F (mm)	12.700 x 38.10
F (in)	-
Weight (kg)	4.24
Weight (lbs)	9.35